

Spannzangen Typ Erickson

Collets type Erickson



Typ 412 E (DK-S), 0,25 mm steigend / stepped

D mm	d3 mm	l1 mm	Art.-Nr. / Order no.
1-2	6,8	16,3	▶ 06-412E-Ø
2,25-3	6,8	16,3	▶ 06-412E-Ø
3,25-4	6,8	16,3	▶ 06-412E-Ø

Typ 416 E (DK30), 0,5 mm steigend / stepped

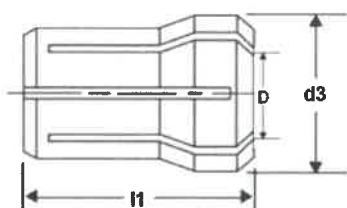

D mm	d3 mm	l1 mm	Art.-Nr. / Order no.
1-2,5	9,5	25,4	▶ 06-416E-Ø
3-6,5	9,5	25,4	▶ 06-416E-Ø

Typ 417 E (DK20), 0,5 mm steigend / stepped

D mm	d3 mm	l1 mm	Art.-Nr. / Order no.
1-2,5	13,6	30,3	▶ 06-417E-Ø
3-10	13,6	30,3	▶ 06-417E-Ø

Typ 418 E (DK10), 0,5 mm steigend / stepped

D mm	d3 mm	l1 mm	Art.-Nr. / Order no.
1-2,5	19,4	36,7	▶ 06-418E-Ø
3-14,5	19,4	36,7	▶ 06-418E-Ø

Sonstige Spannzangen, rund Collets, round

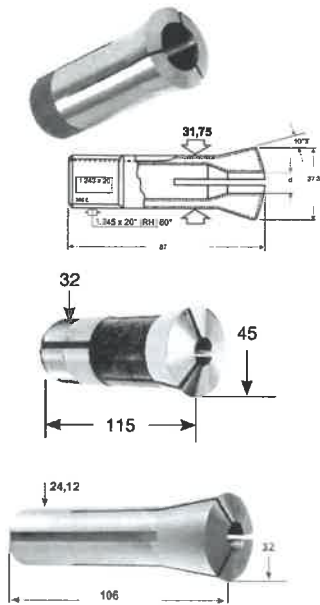

Typ 385 E (5C), 0,5 mm steigend / 0,5 mm stepped

D mm	Art.-Nr. / Order no.
1 - 2,5 mm	06-385E-Ø
3 - 27 mm	06-385E-Ø
27,5 - 30 mm	06-385E-Ø

Typ 386 E, 0,5 mm steigend / 0,5 mm stepped

D mm	Art.-Nr. / Order no.
1 - 2,5 mm	06-386E-Ø
3 - 29 mm	06-386E-Ø

Typ 369 E (R8), 1 mm steigend / 1 mm stepped

D mm	Art.-Nr. / Order no.
2 mm	06-369E-Ø
3 - 22 mm	06-369E-Ø

Direktspannzangen Taper collets



Mit Morsekegel With morse taper

MK / MT	Ø mm	Innengewinde / Internal thread	Art.-Nr. / Order no.
2	2, 3, 4, 5, 6, 8, 10, 12	M10	06-228-2-Ø
3	3, 4, 5, 6, 8, 10, 12, 14, 16, 18	M12	06-228-3-Ø
4	3, 4, 5, 6, 8, 10, 12, 14, 16, 18, 20, 22, 24, 25	M16	06-228-4-Ø



Typ 574 E mit Steilkegel Type 574 E with steep taper

SK	Ø mm	Gewinde / Thread	Art.-Nr. / Order no.
40	4, 5, 6, 8, 10, 12, 14, 16, 18, 20, 22, 24, 25	S20 x 2	06-DSSK-S20-Ø



Typ 575 E mit Steilkegel Type 575 E with steep taper

SK	Ø mm	Gewinde / Thread	Art.-Nr. / Order no.
40	4, 5, 6, 8, 10, 12, 14, 16, 18, 20, 22, 24, 25	M16	06-DSSK-M16-Ø

Spannzangen DIN 6343 Collets DIN 6343

Typ 161 E, 0,5 mm steigend / 0,5 mm stepped

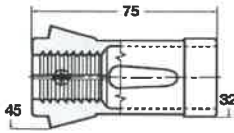

D mm	Form / form	Art.-Nr. / Order no.
3-26 mm	rund / round	06-161E-Ø

Bis Ø 7 mm - glatte Bohrung, ab Ø 8 mit Querrillen
Up to Ø 7 mm - smooth bore, from Ø 8 mm - radial grooved

Typ 163 E, 0,5 mm steigend / 0,5 mm stepped

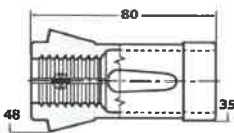

D mm	Form / form	Art.-Nr. / Order no.
2-30 mm	rund / round	06-163E-Ø
Nofallspannzange / Emergency collet 163 E		06-163E-NOT

Bis Ø 7 mm - glatte Bohrung, ab Ø 8 mit Querrillen
Up to Ø 7 mm - smooth bore, from Ø 8 mm - radial grooved

Typ 173 E, 0,5 mm steigend / 0,5 mm stepped

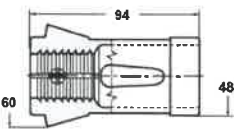

Größe / Size	Form / form	Art.-Nr. / Order no.
Ø 3 - 42 mm	rund / round	06-173E-Ø
□ 4 - 30 mm	vierkant / square	06-173E-Ø-4Kant
◇ 4 - 36 mm	sechskant / hexagonal	06-173E-Ø-6Kant
Nofallspannzange / Emergency collet 173 E		06-173E-NOT

Bis Ø 7 mm - glatte Bohrung, ab Ø 8 mit Querrillen
Up to Ø 7 mm - smooth bore, from Ø 8 mm - radial grooved

Typ 185 E, 1 mm steigend / 1 mm stepped

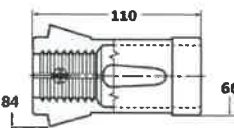

Größe / Size	Form / form	Art.-Nr. / Order no.
Ø 4 - 60 mm	rund / round	06-185E-Ø
□ 10 - 42 mm	vierkant / square	06-185E-Ø-4Kant
◇ 6 - 52 mm	sechskant / hexagonal	06-185E-Ø-6Kant
Nofallspannzange / Emergency collet 185 E		06-185E-NOT

Bis Ø 7 mm - glatte Bohrung, ab Ø 8 mit Querrillen
Up to Ø 7 mm - smooth bore, from Ø 8 mm - radial grooved

Typ 193 E, 5 mm steigend / 5 mm stepped

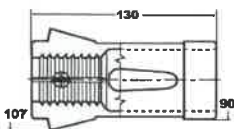

D mm	Form / form	Art.-Nr. / Order no.
20 - 80	rund / round	06-193E-Ø

Weitere Größen auf Anfrage
Further sizes available upon request

Spannzangen-Sätze Collet sets



Sonstige Spannzangen Sätze Optional collet sets

Typ / Type	D mm	Steigung / Stepping	Holzleiste / wooden tray	Anzahl d. Spannzangen / Number of collets	Art.-Nr. / Order no.
385 E	3-26	1	Ja / Yes	24	06-SATZ-385EHL
385 E	1-29	0,5	Nein / No	57	06-SATZ-385/0,5
386 E	3-29	1	Nein / No	24	06-SATZ-386E
173 E	3-42	1	Nein / No	40	06-SATZ-173E
173 E	3-42	0,5	Nein / No	79	06-SATZ-173E/0,5

Anschlagschrauben Stop screws



Für 5C-Spannzangen For 5C-collets

- Gewinde auf ganzer Länge gehärtet
- für einstellbare Werkstücktiefen bis 75 mm (von Spannzangenoberfläche)
- *thread hardened over entire length*
- *for adjustable work piece depths up to 75 mm (from collet surface)*

D
mm

Art.-Nr. /
Order no.

für 5C-Spannzangen / for 5C-collets

06-10622

Für Spannzangen DIN 6343 For collets DIN 6343

- für Spannzangen 163E, 173E, 185E
- *for collets 163E, 173E, 185E*

D
mm

Art.-Nr. /
Order no.

für 173E / for 173E

06-173E-AN

für 185E / for 185E

06-185E-AN